

# Installation Guide

## Agilent Technologies E4428C/38C ESG Signal Generators

This guide applies to the following signal generator models:

**E4428C ESG Analog Signal Generator**

**E4438C ESG Vector Signal Generator**

Due to our continuing efforts to improve our products through firmware and hardware revisions, signal generator design and operation may vary from descriptions in this guide. We recommend that you use the latest revision of this guide to ensure you have up-to-date product information. Compare the print date of this guide (see bottom of page) with the latest revision, which can be downloaded from the following website:

*<http://www.agilent.com/find/esg>*



**Agilent Technologies**

**Manufacturing Part Number: E4400-90502**

**Printed in USA**

**May 2013**

© Copyright 2001–2013 Agilent Technologies, Inc.

---

## Notice

The material contained in this document is provided “as is”, and is subject to being changed, without notice, in future editions.

Further, to the maximum extent permitted by applicable law, Agilent disclaims all warranties, either express or implied with regard to this manual and to any of the Agilent products to which it pertains, including but not limited to the implied warranties of merchantability and fitness for a particular purpose. Agilent shall not be liable for errors or for incidental or consequential damages in connection with the furnishing, use, or performance of this document or any of the Agilent products to which it pertains. Should Agilent have a written contract with the User and should any of the contract terms conflict with these terms, the contract terms shall control.

<b>1. Safety Information</b> .....	<b>1</b>
Warnings, Cautions, and Notes .....	2
Instrument Markings .....	3
General Safety Considerations .....	5
<b>2. Getting Started</b> .....	<b>7</b>
Checking the Shipment .....	8
Meeting Electrical and Environmental Requirements .....	9
Environment .....	9
Ventilation .....	9
Line Settings .....	10
Connecting the AC Power Cord .....	10
Configuring the Display .....	12
Adjusting Contrast and Brightness .....	12
Setting Inverse Video .....	12
Configuring the Screen Saver .....	12
Updating the Display During Remote Operation .....	13
Configuring for Remote Control .....	14
GPIB Interface Configuration .....	14
LAN Interface Configuration .....	14
RS-232 Interface Configuration .....	16
Ordering Accessories .....	17
Front Handles and Rack Mount Flanges .....	17
ESG Documentation .....	17
Proper Usage and Cleaning .....	19
Cleaning Suggestions .....	19
Returning a Signal Generator to Agilent Technologies .....	20
Contacting Agilent Sales and Service Offices .....	21
<b>3. Operation Verification</b> .....	<b>23</b>
Operation Verification .....	24
Required Equipment .....	24
Power On the Signal Generator .....	25
Check for Error Messages .....	26
Frequency Range and Accuracy Check .....	27
Connect the Test Equipment .....	27
Configure the Signal Generator .....	27
Configure the Frequency Counter .....	27

---

# Contents

Measure the Frequency Accuracy . . . . .	28
Power Level Accuracy Check . . . . .	29
Connect the Test Equipment for Setup 1 . . . . .	29
Configure the Signal Generator . . . . .	29
Configure the Power Meter . . . . .	30
Measure the Power Level Accuracy . . . . .	30
Connect the Test Equipment for Setup 2 . . . . .	30
Configure the Signal Generator . . . . .	30
Configure the Spectrum Analyzer . . . . .	31
Measure the Power Level Accuracy . . . . .	31
Calculate the Actual Power Level . . . . .	32
FM Accuracy Check . . . . .	33
Connect the Test Equipment . . . . .	33
Configure the Signal Generator . . . . .	33
Configure the Measuring Receiver . . . . .	33
Measure the Deviations . . . . .	34
AM Accuracy Check . . . . .	35
Connect the Test Equipment . . . . .	35
Configure the Signal Generator . . . . .	35
Configure the Measuring Receiver . . . . .	35
Measure the Deviations . . . . .	36
I/Q Modulation Check . . . . .	37
Option UN7 (BERT) Check . . . . .	38
Verification Setup . . . . .	38
Test Tables . . . . .	44
<b>4. Regulatory Information . . . . .</b>	<b>55</b>
Statement of Compliance . . . . .	56
Assistance . . . . .	56
Certification . . . . .	56
Compliance with German Noise Requirements . . . . .	56
Declaration of Conformity . . . . .	57

# Documentation Overview

## **Installation Guide**

- Safety Information
- Getting Started
- Operation Verification
- Regulatory Information

## **User's Guide**

- E4428C Analog Signal Generator Overview
- E4423C Analog Signal Generator Overview
- Basic Operation
- Basic Digital Operation
- AWGN Waveform Generator
- Analog Modulation
- Digital Signal Interface Module
- Bluetooth Signals
- BERT
- CDMA Digital Modulation
- GPS Modulation
- Multitone Waveform Generator
- Custom Digital Modulation
- Real Time TDMA Formats
- W-CDMA Digital Modulation for Component Test
- W-CDMA Uplink Digital Modulation for Receiver Test
- W-CDMA Downlink Digital Modulation for Receiver Test
- Troubleshooting

## **Programming Guide**

- Getting Started with Remote Operation
- Using IO Interfaces
- Programming Examples
- Programming the Status Register System
- Creating and Downloading Waveform Files
- Creating and Downloading User-Data Files

**SCPI Reference**

## Volume 1:

- SCPI Basics
- Basic Function Commands
- System Commands
- Analog Commands
- Component Test Digital Commands

## Volume 2:

- Digital Signal Interface Module Commands
- Bit Error Rate Test (BERT) Commands
- Receiver Test Digital Commands

## Volume 3:

- Receiver Test Digital Commands (continued)

**Compatibility with E44xxB SCPI Commands**

- Overview
- E4428C/38C SCPI Commands
- ESG E44xxB Commands
- 8648A/B/C/D Commands
- 8658B, 8657A/B/D/J Programming Codes

**Service Guide**

- Troubleshooting
- Replaceable Parts
- Assembly Replacement
- Post-Repair Procedures
- Safety and Regulatory

**Key and Data Field Reference**

## Volume 1:

- Symbols, Numerics, A-H

## Volume 2:

- Volume 2: I-Z

---

# 1 Safety Information

## Warnings, Cautions, and Notes

The following safety notations are used throughout this manual. Familiarize yourself with each notation and its meaning before operating the signal generator.

---

**WARNING**      ***Warning* denotes a hazard. It calls attention to a condition or situation that could result in personal injury or loss of life. Do not proceed beyond a warning until the indicated conditions or situations are fully understood.**

---

---

**CAUTION**      *Caution* calls attention to a possible condition or situation that could result in the loss of a user's work, damage, or destruction of the signal generator. Do not proceed beyond a caution until the indicated conditions are fully understood.

---

---

**NOTE**      *Note* calls the user's attention to an important point or special information within the text. It provides operational information or additional instructions of which the user should be aware.

---



---

## Instrument Markings

The following markings are used on the signal generator. Familiarize yourself with each marking and its meaning before operating the signal generator.



The instruction manual symbol. The product is marked with this symbol when it is necessary for the user to refer to the instructions in the manual.



The CE mark is a registered trademark of the European Community. If this symbol is accompanied by a year, it is the year when the design was proven.



The CSA mark is a registered trademark of the Canadian Standards Association.



The C-Tick Mark is a trademark registered to the Australian Spectrum Management Agency. This indicates compliance with all Australian EMC regulatory information.



This symbol is used to mark the on position of the power line switch.



This symbol is used to mark the standby position of the power line switch.



This symbol indicates that the input power required is ac.



This is a symbol of an Industrial Scientific and Medical Group 1 Class A product. (CISPER 11, Clause 4)



This equipment is Class A suitable for professional use and is for use in electromagnetic environments outside of the home.

**South Korean Class A EMC Declaration**  
A 급 기기 ( 업무용 방송통신기자재 )

이 기기는 업무용 (A 급) 전자파적합기기로서 판매자 또는 사용자는 이 점을 주의하시기 바라 며, 가정외의 지역에서 사용하는 것을 목적으로 합니다.

Safety Information  
Instrument Markings



This product complies with the WEEE Directive (2002/96/EC) marking requirements. The affixed label indicates that you must not discard this electrical/electronic product in domestic household waste.

Product Category: With reference to the equipment types in the WEEE Directive Annex 1, this product is classed as a “Monitoring and Control instrumentation” product.

Do not dispose in domestic household waste.

To return unwanted products, contact your local Agilent office, or see <http://www.agilent.com/environment/product/> for more information.

---

## General Safety Considerations

---

**WARNING**      **Personal injury may result if the signal generator covers are removed. There are no operator serviceable parts inside. To avoid electrical shock, refer servicing to qualified personnel.**

---

Safety Information  
**General Safety Considerations**

---

## 2 Getting Started

## Checking the Shipment

1. Inspect the shipping container for damage.

Signs of damage may include a dented or torn shipping container or cushioning material that indicates signs of unusual stress or compacting.

2. Carefully remove the contents from the shipping container and verify that your order is complete.

The following items are shipped standard with each signal generator:

- installation guide
  - documentation CD-ROM
- CD-ROM contents are also available in hard copy format. Refer to [“ESG Documentation” on page 17](#) for more information.
- three-prong ac power cord (specific to geographic location)

3. Verify that any options ordered are included with the shipment by checking the serial number label on the rear of the signal generator and the packing literature included with the shipment.

Front handles and rack mounting hardware are also available for your signal generator. Refer to [“Front Handles and Rack Mount Flanges” on page 17](#) for more information.

## Meeting Electrical and Environmental Requirements

### Environment

The signal generator is designed for use in the following environmental conditions:

- indoor use
- altitudes < 15,000 feet (4,572 meters)
- 0 to 55° C temperature, unless otherwise specified
- 5 to 95 % relative humidity (maximum) for temperatures up to 31° C, decreasing linearly to 50% relative humidity at 40° C
- mains supply voltage must not fluctuate more than  $\pm 10\%$
- enclosure protection IP Class 20, according to IEC 529

---

**CAUTION** This product is designed for use in INSTALLATION CATEGORY II and POLLUTION DEGREE 2, per IEC 61010-1 and 664, respectively.

---

### Ventilation

Ventilation holes are located on the rear panel and all four sides of the signal generator cover. Do not allow these holes to be obstructed, as they allow air flow through the signal generator.

When installing the signal generator in a cabinet, the convection into and out of the signal generator must not be restricted. The ambient temperature outside the cabinet must be less than the maximum operating temperature of the signal generator by 4° C for every 100 watts dissipated within the cabinet.

---

**CAUTION** Damage to the signal generator may result when the total power dissipated in the cabinet is greater than 800 watts. When this condition exists, forced convection must be applied.

---

## Line Settings

The signal generator has an autoranging line voltage input. The available ac power source must meet the following conditions:

**Voltage:** 100/115 volts nominal (90-132 volts)

230/240 volts nominal (198-254 volts)

**Frequency:** for 100/115 volts: 50/60 Hz nominal  
50/60/400 Hz nominal (instruments with serial prefixes  
≥US4907/MY4907)

for 230/240 volts: 50/60 Hz nominal  
50/60/400 Hz nominal (instruments with serial prefixes  
>US4907/MY4907)

**Power:** 200 watts maximum

---

**CAUTION** Damage to the signal generator may result if the supply voltage is not within the specified range.

---

## Connecting the AC Power Cord

This is a Safety Class 1 Product provided with a protective earth ground incorporated into the power cord. The front panel switch is only a standby switch; it is not a line switch. The ac power cord is the disconnecting device that disconnects the signal generator mains circuits from the mains supply. Alternatively, an external switch or circuit breaker, readily identifiable and easily reached by the operator, may also be used as a disconnecting device.

Perform the following steps when connecting the ac power cord:

---

**WARNING** **Personal injury may occur if there is any interruption of the protective conductor inside or outside of the signal generator. Intentional interruption is prohibited.**

---

---

**CAUTION** Damage to the signal generator may result without adequate earth grounding. Always use the three-prong ac power cord supplied with the signal generator.

---



1. Ensure that the power cord is not damaged.
2. Install the signal generator so that one of the following items is readily identifiable and easily reached by the operator: ac power cord, alternative switch, or circuit breaker.
3. Insert the mains plug into a socket outlet provided with a protective earth grounding.

## Configuring the Display

You can adjust the LCD display using features such as contrast, brightness, screen saver mode, and the screen saver delay. You can also toggle features such as inverse video, display updating in remote mode, and the screen saver on or off.

### Adjusting Contrast and Brightness

Press  to decrease the display contrast.

Pressing the decrease contrast hardkey and holding it down causes the display background to gradually darken in comparison to the text on the display. The minimum contrast setting is not a completely black display. Some contrast between the background and the text will still be visible.

Press  to increase the display contrast

Pressing the increase contrast hardkey and holding it down causes the display background to gradually brighten in comparison to the text on the display. If the background does not appear to change, it is probably set to the maximum contrast.

Press **Utility > Display > Brightness**.

This allows for adjustment of the display's brightness.

Use the arrow keys, numeric keypad, or front panel knob to adjust the display brightness. The brightness value is set to 50 (maximum brightness) at the factory. The minimum brightness value is 1.

### Setting Inverse Video

Press **Utility > Display > Inverse Video Off On**.

This toggles between inverse video mode and normal display mode.

The normal display mode for the signal generator is dark text on a light background. Inverse video mode is light text on a dark background. Inverse video is a persistent state; it is not affected by a signal generator preset or power cycle.

### Configuring the Screen Saver

Press **Utility > Display > Screen Saver Off On**.

This toggles the operating mode of the screen saver.

Extend the life expectancy of the signal generator's display light by activating the screen saver. Leaving the display lit for long periods of time or turning the display on and off frequently decreases the life of the bulb.

With the screen saver on, the display light is turned off after a defined period of time with no input to the front panel. The display light turns on again when any front panel key is pressed or when a remote command is sent. The screen saver is set to off at the factory.

Press **Utility > Display > Screen Saver Mode**.

This toggles the screen saver mode between light-only mode and light-and-text mode.

Adjust the screen saver mode to turn the light on, off, or to turn both the light and text on and off. Setting the mode to light-only mode turns the display light off, leaving the text visible at a low intensity. If the display remains unchanged for long periods of time, set the mode to light and text to prevent the text from burning the display. This mode turns the display light and the text off.

Press **Utility > Display > Screen Saver Delay**.

This adjusts the amount of elapsed time before the screen saver is activated.

The screen saver delay is set to 1 hour at the factory. The current screen saver delay is displayed in the softkey label in addition to the active entry area. To change the delay, enter a new value using the numeric keypad or by rotating the front panel knob and then press **Enter**. The acceptable range of the delay value is 1 through 12 hours (1 hour increments).

The screen saver settings are persistent states; they are not affected by a signal generator preset or power cycle.

## Updating the Display During Remote Operation

Press **Utility > Display > Update in Remote Off On**.

This toggles the display-update-in-remote mode on or off.

When toggled on, commands executed via the remote control bus will update the signal generator display accordingly. When toggled off, commands executed via the remote control bus will not update the signal generator's display. Update-in-remote mode is set to off at the factory.

## Configuring for Remote Control

### GPIB Interface Configuration

1. Press **Utility** > **GPIB/RS-232 LAN** > **GPIB Address**.
2. Use the numeric keypad to set the desired address.

Alternatively, use the arrow keys or the front panel knob to set the desired address. If either alternative is used, step 3 is not required.

3. Press **Enter**.

The signal generator's GPIB address is set to 19 at the factory. The acceptable range of addresses is 0 through 30.

The GPIB address is a persistent state; it is not affected by a signal generator preset or by a power cycle.

### LAN Interface Configuration

Use one of the following procedures to assign a hostname and IP address to the signal generator. The hostname and IP address are persistent states; they are not affected by an instrument preset or a power cycle.

---

**NOTE** Verify that the signal generator is connected to the LAN using a 10Base-T LAN cable.

---

### Manual Configuration

1. Press **Utility** > **GPIB/RS-232 LAN** > **LAN Setup**.
2. Press **Hostname**.

---

**NOTE** The **Hostname** softkey is only available when **LAN Config Manual DHCP** is set to **Manual**.

---

3. Use the labeled text softkeys or numeric keypad or both to enter the desired hostname. To erase the current hostname, press **Editing Keys** > **Clear Text**.
4. Press **Enter**.
5. Press **LAN Config Manual DHCP** to **Manual**.

6. Press **IP Address** and enter a desired address.

Use the left and right arrow keys to move the cursor. Use the up and down arrow keys, front panel knob, or numeric keypad to enter an IP address. To erase the current IP address, press the **Clear Text** softkey.

---

**NOTE** To remotely access the signal generator from a different LAN subnet, you must also enter the subnet mask and default gateway. See your system administrator to obtain the appropriate values.

---

7. Press the **Proceed With Reconfiguration** softkey, and then the **Confirm Change (Instrument will Reboot)** softkey.

This action assigns the hostname and IP address (as well as a gateway and subnet mask, if these have been configured) to the signal generator. The hostname, IP address, gateway and subnet mask are not affected by an instrument preset or by a power cycle.

### DHCP Configuration

1. Press **Utility > GPIB/RS-232 LAN > LAN Setup**.

---

**NOTE** If the DHCP server uses dynamic DNS to link the hostname with the assigned IP address, the hostname may be used in place of the IP address. Otherwise, the hostname is not usable and you may skip steps 2 through 4.

---

2. Press **Hostname**.

---

**NOTE** The **Hostname** softkey is only available when **LAN Config Manual DHCP** is set to **Manual**.

---

3. Use the labeled text softkeys or numeric keypad, or both to enter the desired hostname.

To erase the current hostname, press **Editing Keys > Clear Text**.

4. Press **Enter**.
5. Press **LAN Config Manual DHCP** to **DHCP**.
6. Press the **Proceed With Reconfiguration** softkey and then the **Confirm Change (Instrument will Reboot)** softkey.

This action configures the signal generator as a DHCP client. In DHCP mode, the signal generator will request a new IP address from the DHCP server upon rebooting. You can return to the LAN Setup menu after rebooting to determine the assigned IP address.

## RS-232 Interface Configuration

1. Press **Utility** > **GPIB/RS-232 LAN** > **RS-232 Setup**.
2. Press **RS-232 Baud Rate**.
3. Press the desired baud rate softkey.
4. Press **RS-232 Echo Off On**.

This toggles the state of the SCPI echoing on the RS-232 connection. Set as desired.

5. Press **Reset RS-232**.

This deletes the data from the RS-232 buffer, discarding any unprocessed SCPI input received over RS-232.

The RS-232 parameters are persistent states; these states are not affected by an instrument preset or power cycle.

## Ordering Accessories

The following accessories are available for order when a signal generator is purchased, or at any time afterward. To order accessories, refer to “[Contacting Agilent Sales and Service Offices](#)” on page 21.

### Front Handles and Rack Mount Flanges

Handles can be purchased and attached to the front of the signal generator. These handles can also be purchased with a rack mount kit to facilitate rack installation. Hardware can be ordered as a kit to support either preference. [Table 2-1](#) lists the part numbers for these kits.

**Table 2-1 Front Handle and Rack Mount Flange Kits**

Description	Part Number
Front Handle Kit	5063-9227
Rack Mount Kit with Handles	5063-9221

### ESG Documentation

[Table 2-2](#) lists the part numbers and descriptions for documentation available in hardcopy and CD-ROM format.

**Table 2-2 Available ESG Documentation**

Document Type	Description	Part Number
ESG Document Set	<ul style="list-style-type: none"> <li>set includes all items listed in this table, with the exception of the installation guide, the service guide, and documentation CD-ROM</li> </ul>	E4400-90500
Documentation CD-ROM	<ul style="list-style-type: none"> <li>PDF files:                             <ul style="list-style-type: none"> <li>— ESG Documentation set</li> <li>— Installation Guide</li> <li>— Service Guide</li> <li>— Error Messages</li> </ul> </li> <li>programming examples</li> </ul>	E4400-90501
Installation Guide	<ul style="list-style-type: none"> <li>installation requirements and instructions</li> <li>operation verification procedure</li> <li>safety, and regulatory information</li> </ul>	E4400-90502
Data Sheet	<ul style="list-style-type: none"> <li>available options</li> <li>warranted technical specifications and typical performance</li> </ul>	5988-4039EN

**Table 2-2 Available ESG Documentation**

Document Type	Description	Part Number
User's Guide	<ul style="list-style-type: none"> <li>• description of features and functions</li> <li>• signal generator operation tutorials</li> <li>• troubleshooting and optimization procedures</li> <li>• component test procedures and concept information</li> <li>• receiver test procedures and concept information</li> </ul>	E4400-90503
Key and Data Field Reference - Volume 1	<ul style="list-style-type: none"> <li>• key and data field descriptions</li> </ul>	E4400-90504
Key and Data Field Reference - Volume 2	<ul style="list-style-type: none"> <li>• key and data field descriptions <i>continued</i></li> </ul>	E4400-90515
Programming Guide	<ul style="list-style-type: none"> <li>• remote operation and data transfer procedures</li> <li>• programming examples</li> </ul>	E4400-90505
Programming Compatibility Guide	<ul style="list-style-type: none"> <li>• supported SCPI commands for backwards compatibility</li> </ul>	E4400-90543
SCPI Command Reference Volume 1	<ul style="list-style-type: none"> <li>• SCPI command descriptions</li> </ul>	E4400-90506
SCPI Command Reference Volume 2	<ul style="list-style-type: none"> <li>• SCPI command descriptions <i>continued</i></li> </ul>	E4400-90535
SCPI Command Reference Volume 3	<ul style="list-style-type: none"> <li>• SCPI command descriptions <i>continued</i></li> </ul>	E4400-90594
Service Guide	<ul style="list-style-type: none"> <li>• assembly-level documentation</li> <li>• troubleshooting procedures</li> <li>• parts information</li> </ul>	E4400-90511



---

## Proper Usage and Cleaning

The signal generator cover protects against physical contact with internal assemblies that contain hazardous voltages, but does not protect against the entrance of water. To avoid damage and personal injury, ensure that liquid substances are positioned away from your signal generator.

---

**WARNING**      **Personal injury may result if the signal generator is not used as specified. Unspecified use impairs the protection provided by the equipment. The signal generator must be used with all means for protection intact.**

---

### Cleaning Suggestions

To ensure good connections, the connectors on the front and rear panels of the signal generator need to be cleaned regularly.

To prevent dust build-up that could potentially obstruct ventilation, clean the signal generator cover periodically. Use a dry cloth, or one slightly dampened with water, to clean the external case parts.

---

**WARNING**      **Electrical shock may result if the signal generator is not disconnected from the mains supply before cleaning. Do not attempt to clean internally.**

---

## Returning a Signal Generator to Agilent Technologies

To return your signal generator to Agilent Technologies for servicing, follow these steps:

1. Gather as much information as possible regarding the signal generator's problem.
2. Call the phone number listed on the Internet (<http://www.agilent.com/find/assist>) that is specific to your geographic location. If you do not have access to the Internet, contact your Agilent field engineer.

After sharing information regarding the signal generator and its condition, you will receive information regarding where to ship your signal generator for repair.

3. Ship the signal generator in the original factory packaging materials, if available, or use similar packaging to properly protect the signal generator.

## Contacting Agilent Sales and Service Offices

Assistance with test and measurements needs and information on finding a local Agilent office are available on the Internet at:

*<http://www.agilent.com/find/assist>*

You can also purchase E4428C/38C ESG accessories or documentation items on the Internet at:

*<http://www.agilent.com/find/esg>*

If you do not have access to the Internet, please contact your field engineer.

---

**NOTE**      In any correspondence or telephone conversation, refer to the signal generator by its model number and full serial number. With this information, the Agilent representative can determine whether your unit is still within its warranty period.

---

Getting Started

**Contacting Agilent Sales and Service Offices**

---

## 3 Operation Verification

## Operation Verification

Operation verification is a series of tests that, when completed, will either ensure that the signal generator is operating correctly, or will assist in pointing to the problem area. Operation verification does not ensure performance to specifications, but should provide a level of confidence that the signal generator is operating correctly within a minimum amount of time.

Operation verification is appropriate for incoming inspection, after repair (when a full calibrated performance is not required), or whenever the integrity of the signal generator is in question.

Perform the following tests in the order they are presented. The tables referenced by the tests are located in the rear of the chapter, where they can be copied easily.

1. [Power On the Signal Generator on page 25](#)
2. [Check for Error Messages on page 26](#)
3. [Frequency Range and Accuracy Check on page 27](#)
4. [Power Level Accuracy Check on page 29](#)
5. [FM Accuracy Check on page 33](#)
6. [AM Accuracy Check on page 35](#)
7. [I/Q Modulation Check on page 37](#)
8. [Option UN7 \(BERT\) Check on page 38](#)

### Required Equipment

- Agilent 53132A Option 050 Frequency Counter
- Agilent E4418B or E4419B Power Meter
- Agilent E9304A Power Sensor
- Agilent E444xA Spectrum Analyzers with Option 1DS
- Agilent 8491A/B Option 006 Attenuator (6 dB)
- Agilent 8491A/B Option 010 Attenuator (10 dB)
- Agilent 8902A Measuring Receiver

## Power On the Signal Generator

This procedure verifies that the signal generator powers up and that the internal instrument check identifies no errors. The internal check evaluates operation and, if a problem is detected, returns an error message.

1. Power on the signal generator by pressing the front panel power switch. The green LED will light once power is activated. Let the signal generator warm up for one hour.

---

**NOTE** For ESG signal generators with Option UNJ, or those with Option 1E5, ERROR 514, Reference Oven Cold occurs whenever the signal generator is first connected to ac line power. The OVEN COLD annunciator and the ERR annunciator both turn on. The OVEN COLD annunciator automatically clears after approximately 5 minutes. The error queue *cannot* be cleared, however, until the OVEN COLD annunciator has turned off.

---

2. Cycle the power to the signal generator. The green LED should again be lit and the signal generator will perform a check.

## Check for Error Messages

1. Check the display to see if the ERR annunciator is turned on.
2. If the ERR annunciator is turned on, review the error messages in the queue by pressing **Utility > Error Info**. The first error message in the queue will be shown in the text area of the display.

Refer to the “Error Messages” on the Documentation CD-ROM for further information about specific error messages. Refer to [Table 2-2, “Available ESG Documentation,” on page 17 in Chapter 2, “Getting Started.”](#)

If there is more than one error message (each message will be designated as 1 of *n*), press the **View Next Error Message** softkey until you have seen all of the messages.

3. When you have resolved all of the error messages, press **Clear Error Queue(s)** to delete the messages.
4. Cycle the power on the signal generator and then restart this procedure until the signal generator powers on without displaying the ERR annunciator.



---

## Frequency Range and Accuracy Check

The frequency range is tested by determining the frequency accuracy relative to the timebase at the frequency limits of the signal generator.

### Connect the Test Equipment

Figure 3-1 Frequency Range and Accuracy Equipment Setup

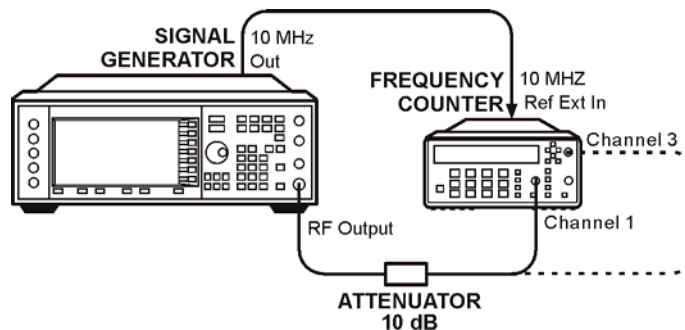

### Configure the Signal Generator

1. Press **Preset**.
2. Press **Mod On/Off**. The MOD OFF annunciator is now displayed.
3. Press **Amplitude**. Enter 0 using the numeric keypad and press the **dBm** terminator softkey.
4. Press **RF On/Off**. The RF ON annunciator is now displayed.

### Configure the Frequency Counter

1. Observe the display. Verify that the counter is frequency-locked to the 10 MHz external reference ( $\pm 1$  Hz).
2. For frequencies  $< 150$  MHz, use Channel 3. Press **Freq Ratio** until CH3: is displayed.  
The input impedance of this channel is a persistent  $50\Omega$ .

---

**NOTE** For greater counter resolution accuracy, set the gate time to  $> 5$  seconds for maximum counter accuracy. Press **Gate & ExtArm** twice and use the arrow keys to set value.

---

### Measure the Frequency Accuracy

1. Set the signal generator to each frequency listed in [Table 3-7, “Frequency Accuracy,”](#) on page 44.
2. Record the measured frequency in [Table 3-7](#) and compare it to the corresponding limits.

---

## Power Level Accuracy Check

Performing this check will provide a high level of confidence that the signal generator's power level circuitry is functioning correctly. This check does not test the signal generator to warranted specifications. Test points have been reduced and the limits are degraded in order to minimize measurement time and take into account a broad range of measurement uncertainties.

In order to have the signal generator tested to warranted specifications, a complete power level accuracy performance test is required. If the complete performance test is needed and you are unable to perform it, contact your nearest Agilent Technologies service center for information concerning calibration. Refer to [“Contacting Agilent Sales and Service Offices”](#) on page 21 for contact information.

### Connect the Test Equipment for Setup 1

Figure 3-2

Power Level Accuracy Equipment Setup 1

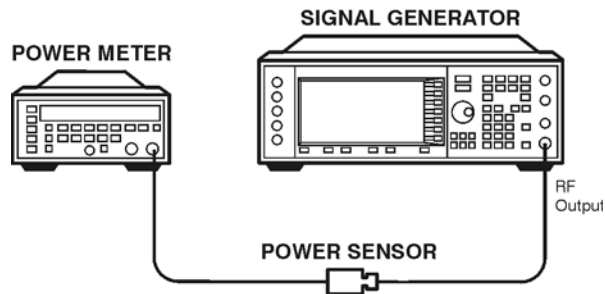

jk72c

### Configure the Signal Generator

1. Press **Preset**.
2. Press **Frequency**. Enter 277 using the numeric keypad and press the **kHz** terminator softkey.
3. Press **Amplitude**. Enter 13 using the numeric keypad and press the **dBm** terminator softkey.
4. Press **Mod On/Off**. The MOD OFF annunciator is displayed.
5. Press **RF On/Off**. The RF ON annunciator is displayed.

## Configure the Power Meter

1. Zero and calibrate the power meter to the sensor's reference calibration factor.
2. Set the power meter to measure absolute log power (dBm).

## Measure the Power Level Accuracy

1. Set the power levels and frequencies for the signal generator to the maximum signal generator frequency. Refer to [Table 3-8, "Power Level Accuracy Setup 1,"](#) on page 45.
2. Set the power sensor's calibration factor for each frequency.
3. Record the measured power level in [Table 3-8](#) and compare it to the corresponding limits.

## Connect the Test Equipment for Setup 2

Figure 3-3 Power Level Accuracy Equipment Setup 2

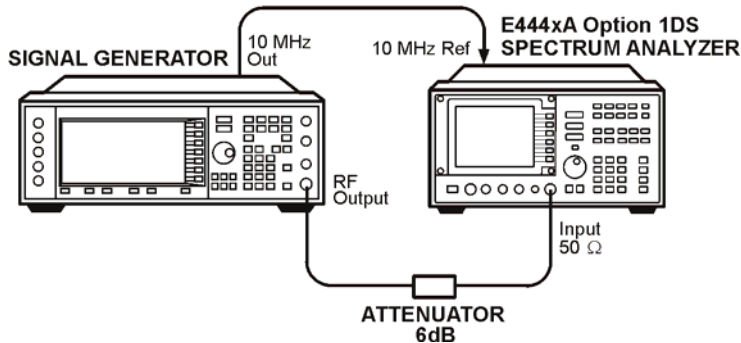

## Configure the Signal Generator

1. Press **Frequency**. Enter 277 using the numeric keypad and press the kHz terminator softkey.
2. Press **Amplitude**. Enter -45 using the numeric keypad and press the dBm terminator softkey.

## Configure the Spectrum Analyzer

1. Preset the spectrum analyzer.
2. Set the analyzer to external 10 MHz reference.
3. Set the center frequency to 277 kHz.
4. Set the frequency span to 100 Hz. (This will result in a 1 Hz resolution bandwidth with a digital filter.)

## Measure the Power Level Accuracy

1. Transfer the power level results for each frequency at  $-45$  dBm from the Measured Power column in [Table 3-8](#) to the Power Meter Reading for  $-45$  dBm column in [Table 3-9](#).
2. On the spectrum analyzer, use the marker to measure the signal.
  - a. Use the marker peak and search features to set a marker on the signal peak.
  - b. Set the marker to the reference level of the spectrum analyzer.
  - c. Enable the marker delta function. Ensure that the delta shows 0 dB.
3. On the ESG, decrease its amplitude in 10 dB steps as shown for the power levels in [Table 3-9](#) for the current frequency. With each 10 dB step, select the marker menu and peak the marker to ensure that the marker is on the signal peak.
4. Using the marker peak search, reset the marker to the signal peak.
5. Measure the power levels listed in the Power Level Setting (dBm) column of [Table 3-9](#) for the current frequency, and record the values in the Spectrum Analyzer Marker (dB) column.
6. Return the signal generator amplitude to  $-45$  dBm, and set the signal generator frequency and the spectrum analyzer's center frequency to the next frequency listed in [Table 3-9](#) and repeat the process from step 2.
7. Repeat steps 2–6 until all of the frequencies have been measured and recorded (to the maximum signal generator frequency).

## Calculate the Actual Power Level

1. Calculate and record the Actual Power Level, in [Table 3-9](#), as the sum of the Power Meter Reading for  $-45$  dBm and the Spectrum Analyzer Marker (dB) value.

For example:

- Power Meter Reading for  $-45$  dBm at 2.516 MHz =  $-44.95$  dBm
  - Spectrum Analyzer Marker (dB) at 2.516 MHz and Power Level Setting at  $-85$  dBm =  $-40.17$  dB
  - Actual Power Level at 2.516 MHz and  $-85$  dBm:  $(-44.95) + (-40.17) = -85.12$  dBm
2. Compare the calculated Actual Power Level value to the corresponding limits.

---

## FM Accuracy Check

### Connect the Test Equipment

Figure 3-4

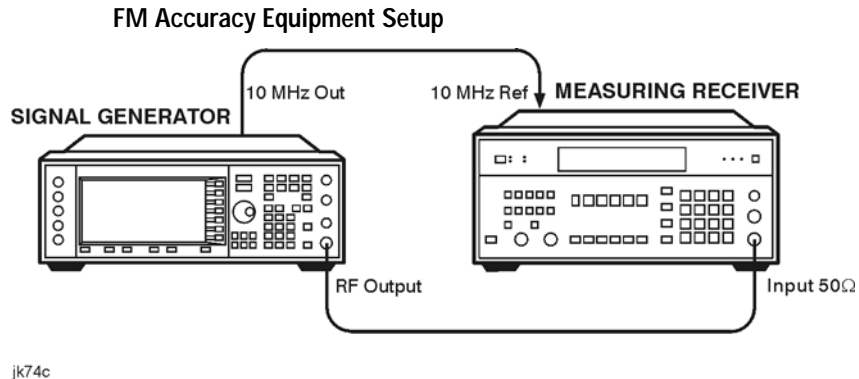

### Configure the Signal Generator

1. Press **Preset**.
2. Press **FM/ΦM > FM Off On**. The FM annunciator is displayed.
3. Press **FM Rate**. Enter 1 using the numeric keypad and press the **kHz** terminator softkey.
4. Press **FM Dev**. Enter 100 using the numeric keypad and press the **kHz** terminator softkey.
5. Press **Amplitude**. Enter 7 using the numeric keypad and press the **dBm** terminator softkey.
6. Ensure that the **MOD ON** annunciator is displayed. If it is not, press **Mod On/Off**.
7. Press **RF On/Off**. The **RF ON** annunciator is displayed.

### Configure the Measuring Receiver

1. Reset the measuring receiver.
2. Set the measuring receiver to FM mode.
3. Turn on Peak+ detector.
4. Turn on the 300 Hz high-pass filter.
5. Turn on the 3 kHz low-pass filter.

## Measure the Deviations

1. Set the signal generator to the frequencies listed in [Table 3-10, “FM Accuracy,”](#) on page 53.
2. Record the deviations measured and compare them to the limits listed in [Table 3-10](#).



---

## AM Accuracy Check

### Connect the Test Equipment

Figure 3-5 AM Accuracy Equipment Setup

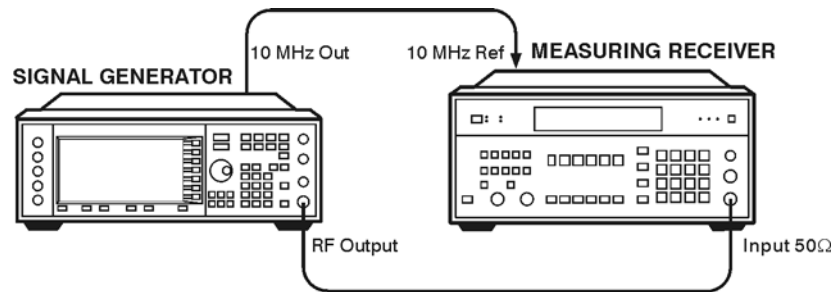

jk75c

### Configure the Signal Generator

1. Press **Preset**.
2. Press **AM > AM Off On**. The **AM** annunciator is displayed.
3. Press **AM Rate**. Enter 1 using the numeric keypad and press the **kHz** terminator softkey.
4. Press **Amplitude**. Enter 7 using the numeric keypad and press the **dBm** terminator softkey.
5. Ensure that the **MOD ON** annunciator is displayed. If it is not, press **Mod On/Off**.
6. Press **RF On/Off**. The **RF ON** annunciator is displayed.

### Configure the Measuring Receiver

1. Reset the measuring receiver.
2. Set the measuring receiver to **AM** mode.
3. Turn on **Peak+** detector.
4. Turn on the 300 Hz high-pass filter.
5. Turn on the 3 kHz low-pass filter.

## Measure the Deviations

1. Set the signal generator to the frequencies and depths listed in [Table 3-11](#), “AM Accuracy,” on page 54.
2. Record the AM depths measured and compare them to the limits listed in [Table 3-11](#).

---

## I/Q Modulation Check

---

**NOTE** The I/Q modulation check is available only in the E4438C ESG vector signal generator with Option 001/601 or 002/602.

---

1. Press **Preset**.
2. Press **I/Q > I/Q Calibration > Calibration Type DC User Full** until **Full** is highlighted.
3. Press **Execute Cal** to begin an I/Q calibration of the full frequency range of the signal generator.

The signal generator displays the message **I/Q Calibration in Progress** while the calibration is occurring.

To abort the I/Q calibration, press **Abort Cal**. The message **I/Q Calibration in Progress Aborting...** is displayed until the calibration is stopped completely.

---

**NOTE** The I/Q calibration is stored in non-volatile memory and remains unchanged during a preset or the power cycle of the signal generator.

---

## Option UN7 (BERT) Check

This procedure is only for the E4438C and verifies the operation of the bit error rate test (BERT) function.

### Verification Setup

1. Refer to [Figure 3-6](#) below and make the following connections on the signal generator's rear panel.
  - DATA OUT (Aux I/O connector pin 1) to BER DATA IN.
  - DATA CLK OUT (Aux I/O connector pin 20) to BER CLK IN.

Figure 3-6 E4438C Rear Panel

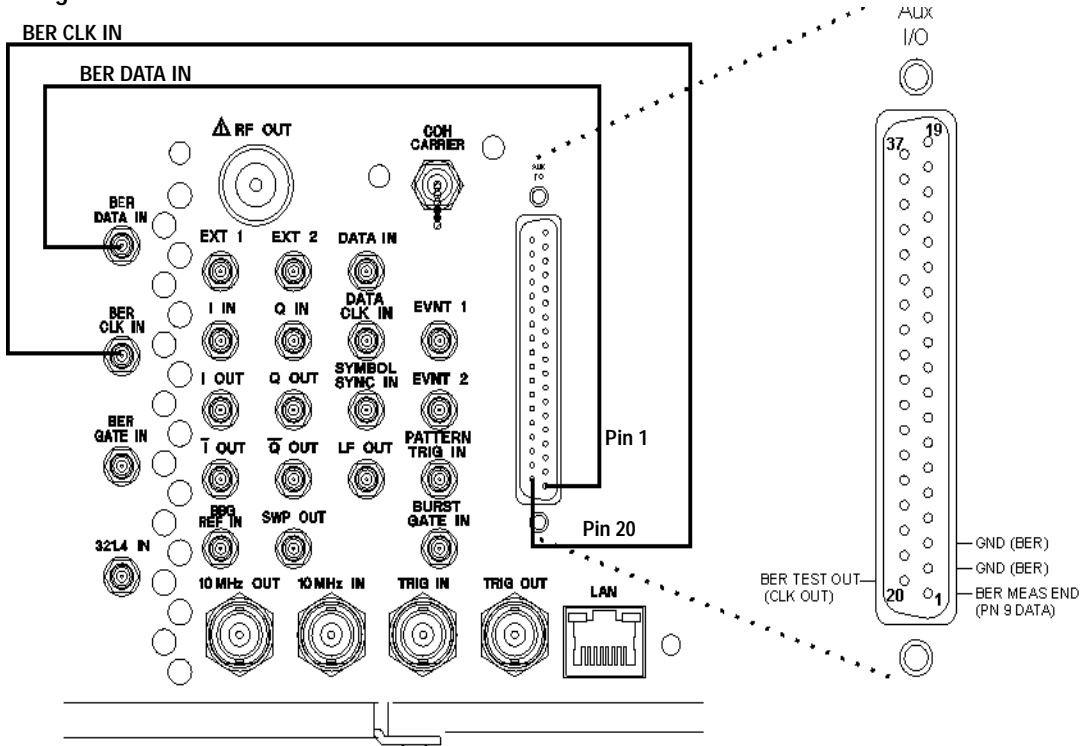

## Configuring the Data

1. Press Preset.
2. For signal generators with Option UN7 only press:  
**Aux Fctn > BERT > BERT Off On to On.**  
For signal generators with Option UN7 and Option 300 press:  
**Aux Fctn > BERT > Baseband BERT > BERT Off On to On.**

## Configuring BERT Parameters

The following steps configure BERT measurement parameters.

1. Press **Configure BERT > Data > PN9**.
2. Press **Total Bits** to 10 Mbits.
3. Press **More (1 of 2) > BERT Resync Off On to Off**.
4. Press **Return > I/O Setup > Polarity Setup > Clock Polarity Pos Neg to Neg**.
5. Press **Return > Aux I/O Out > PN9 Out**.
6. Press **Return > Configure Trigger > Cycle Count 0 > Enter**.

The following figure shows the signal generator's front-panel display after completion of the these steps.

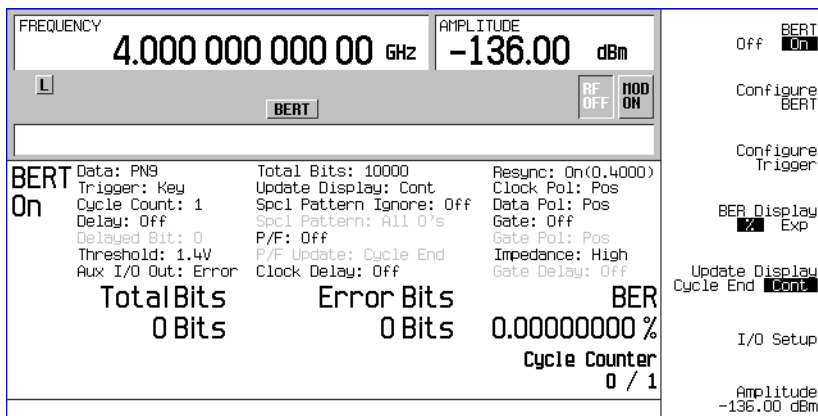

Operation Verification  
**Option UN7 (BERT) Check**

**Verifying BERT Operation**

1. Press **BERT Trigger > Immediate**.

The **Total Bits** counter, in the lower left of the display, counts the number of bits received during each trigger. In this test, the **Total Bits** counter counts from 0 to 10000000.

The **Cycle Counter**, at the lower right of the display, counts the number of measurement triggers received. With the trigger configured to immediate, this count will continue until you change triggers or turn off the BERT measurement. The following figure shows the front-panel display with the **Total Bits** counter updated.

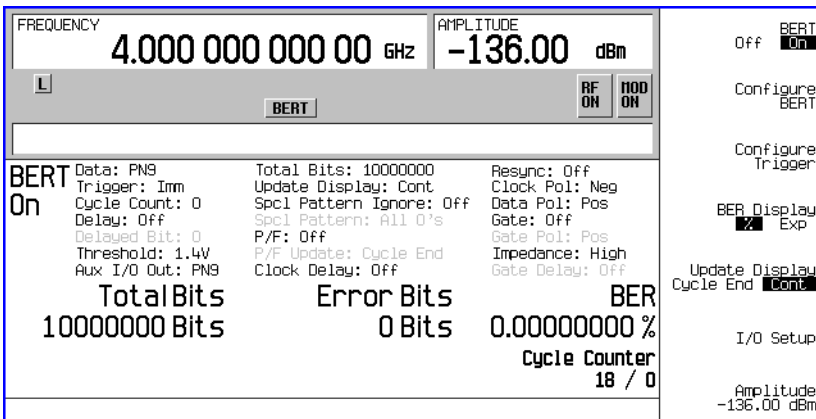

**Table 3-1**

Display Reading	Expected Results
Total Bits	counting up to 10 000 000 Bits
Error Bits	0 Bits
BER	0.00000000%
Cycle Counter	updates with each trigger

If the results are different than those indicated in the table above then re-check the rear-panel Aux I/O to SMB connections and restart the testing with [“Configuring the Data” on page 39](#). If the results are still not correct, contact the Agilent Technologies service center for information and help. See the section [“Contacting Agilent Sales and Service Offices” on page 21](#) for contact information.

2. Disconnect the cable from the BER DATA IN connector.

The following figure shows the front-panel display after disconnecting the cable from the BER DATA IN connector.

Total Bits	Error Bits	BER
77563819 Bits	38857794 Bits	50.09783492 %
No Data		Cycle Counter
		76 / 0

**Table 3-2** Expected Results

Display Reading	Expected Results
Total Bits	counting up to 10 000 000 Bits
Error Bits	no longer 0 Bits
BER	approximately 50.00000000%
No Data	No Data appears in the lower left display

3. Re-connect the cable to the BER DATA IN connector.

**Table 3-3** Expected Results

Display Reading	Expected Results
Total Bits	counting up to 10 000 000 Bits
Error Bits	0 Bits
BER	0.00000000%

Operation Verification  
**Option UN7 (BERT) Check**

4. Disconnect the cable from DATA CLK OUT connector.

The following figure shows the front-panel display when the DATA CLK OUT connector is disconnected.

Total Bits	Error Bits	BER
92429900 Bits	4809 Bits	0.00520286 %
No Clock		Cycle Counter 59 / 0

**Table 3-4 Expected Results**

Display Reading	Expected Results
Total Bits	any number from 0 to 10 000 000 Bits (count does not update)
Error Bits	no longer 0 Bits (count does not update)
BER	no longer 0.00000000% (count does not update)
No Clock	No Clock appears in the lower left on the display.

5. Press **Return > BERT Off On** softkey to Off and to On.

The following figure shows the front-panel display after toggling the **BERT Off On** softkey with DATA CLK OUT connector disconnected.

Total Bits	Error Bits	BER
0 Bits	0 Bits	0.00000000 %
No Clock Sync Loss		Cycle Counter 1 / 0

**Table 3-5 Expected Results**

Display Reading	Expected Results
Total Bits	0 Bits (count does not update)
Error Bits	0 Bits (count does not update)



**Table 3-5 Expected Results**

Display Reading	Expected Results
BER	0.00000000% (count does not update)
No Clock	No Clock appears in the lower left of the display
Sync Loss	Sync Loss appears in the lower left of the display

6. Reconnect the DATA CLOCK OUT connector.

The signal generator returns to normal BERT operation. The following figure shows the front-panel display when the DATA CLK OUT connector is reconnected.

Total Bits	Error Bits	BER
52349492 Bits	0 Bits	0.00000000 %
		Cycle Counter
		3 / 0

**Table 3-6 Expected Results**

Display Reading	Expected Results
Total Bits	any number from 0 to 10 000 000 Bits (count updates)
Error Bits	0 Bits
BER	0.00000000%

If the results of these tests are different from those listed in the Expected Results tables then contact the Agilent Technologies service center for more information and help. See the section [“Contacting Agilent Sales and Service Offices”](#) on page 21 for contact information.

---

## Test Tables

Table 3-7 Frequency Accuracy

Frequency (MHz)	Limits		
	Lower (Hz)	Measured (Hz)	Upper (Hz)
0.25	249 999.		250 001.
0.5	499 999.		500 001.
1	999 999.		1 000 001.
10	9 999 999.		10 000 001.
50	49 999 999.		50 000 001.
100	99 999 999.		100 000 001.
500	499 999 999.		500 000 001.
1000	999 999 999.		1 000 000 001.
2000	1 999 999 999.		2 000 000 001.
3000	2 999 999 999.		3 000 000 001.
4000	3 999 999 999.		4 000 000 001.
5000	4 999 999 999.		5 000 000 001.

Table 3-8 Power Level Accuracy Setup 1

Frequency Setting	Power Level Setting (dBm)	Lower Limit (dBm)	Measured Power (dBm)	Upper Limit (dBm)
277 kHz	+13	12.1		13.9
	+7	6.5		7.5
	0	-0.5		0.5
	-5	-5.5		-4.5
	-15	-15.5		-14.5
	-25	-25.5		-24.5
	-35	-35.5		-34.5
	-45	-45.5		-44.5
2.516 MHz	+13	12.1		13.9
	+7	6.5		7.5
	0	-0.5		0.5
	-5	-5.5		-4.5
	-15	-15.5		-14.5
	-25	-25.5		-24.5
	-35	-35.5		-34.5
	-45	-45.5		-44.5
270.1 MHz	+13	12.1		13.9
	+7	6.5		7.5
	0	-0.5		0.5
	-5	-5.5		-4.5
	-15	-15.5		-14.5
	-25	-25.5		-24.5

Table 3-8 Power Level Accuracy Setup 1

Frequency Setting	Power Level Setting (dBm)	Lower Limit (dBm)	Measured Power (dBm)	Upper Limit (dBm)
	-35	-35.5		-34.5
	-45	-45.5		-44.5
510.1 MHz	+13	12.1		13.9
	+7	6.5		7.5
	0	-0.5		0.5
	-5	-5.5		-4.5
	-15	-15.5		-14.5
	-25	-25.5		-24.5
	-35	-35.5		-34.5
	-45	-45.5		-44.5
990.1 MHz	+13	12.1		13.9
	+7	6.5		7.5
	0	-0.5		0.5
	-5	-5.5		-4.5
	-15	-15.5		-14.5
	-25	-25.5		-24.5
	-35	-35.5		-34.5
	-45	-45.5		-44.5
1350.1 MHz	+10	9.1		10.9
	+7	6.5		7.5
	0	-0.5		0.5
	-5	-5.5		-4.5

Table 3-8 Power Level Accuracy Setup 1

Frequency Setting	Power Level Setting (dBm)	Lower Limit (dBm)	Measured Power (dBm)	Upper Limit (dBm)
	-15	-15.5		-14.5
	-25	-25.5		-24.5
	-35	-35.5		-34.5
	-45	-45.5		-44.5
1950.1 MHz	+10	9.1		10.9
	+7	6.5		7.5
	0	-0.5		0.5
	-5	-5.5		-4.5
	-15	-15.5		-14.5
	-25	-25.5		-24.5
	-35	-35.5		-34.5
	-45	-45.5		-44.5
2310.1 MHz	+10	8.8		11.2
	+7	6.0		8.0
	0	-1.0		1.0
	-5	-6.0		-4.0
	-15	-16.0		-14.0
	-25	-26.0		-24.0
	-35	-36.0		-34.0
	-45	-46.0		-44.0
2985.1 MHz	+10	8.8		11.2
	+7	6.0		8.0

Table 3-8 Power Level Accuracy Setup 1

Frequency Setting	Power Level Setting (dBm)	Lower Limit (dBm)	Measured Power (dBm)	Upper Limit (dBm)
	0	-1.0		1.0
	-5	-6.0		-4.0
	-15	-16.0		-14.0
	-25	-26.0		-24.0
	-35	-36.0		-34.0
	-45	-46.0		-44.0
3225.1 MHz	+7	6.0		8.0
	0	-1.0		1.0
	-5	-6.0		-4.0
	-15	-16.0		-14.0
	-25	-26.0		-24.0
	-35	-36.0		-34.0
	-45	-46.0		-44.0
4000 MHz	+7	5.8		8.2
	0	-1.2		1.2
	-5	-6.2		-3.8
	-15	-16.2		-13.8
	-25	-26.2		-23.8
	-35	-36.2		-33.8
	-45	-46.2		-43.8

Table 3-8 Power Level Accuracy Setup 1

Frequency Setting	Power Level Setting (dBm)	Lower Limit (dBm)	Measured Power (dBm)	Upper Limit (dBm)
<b>Option 506</b>				
5000 MHz	+7	5.8		8.2
	0	-1.2		1.2
	-5	-6.2		-3.8
	-15	-16.2		-13.8
	-25	-26.2		-23.8
	-35	-36.2		-33.8
	-45	-46.2		-43.8
6000 MHz	+7	5.8		8.2
	0	-1.2		1.2
	-5	-6.2		-3.8
	-15	-16.2		-13.8
	-25	-26.2		-23.8
	-35	-36.2		-33.8
	-45	-46.2		-43.8

Table 3-9 Power Level Accuracy Setup 2

Frequency Setting	Power Level Setting (dBm)	Power Meter Reading for -45 dBm	Spectrum Analyzer Marker (dB)	Lower Limit (dBm)	Actual Power Level (dBm)	Upper Limit (dBm)
277 kHz	-45		0 (Ref)	N/A	N/A	N/A
	-55			-56		-54
	-65			-66		-64
	-75			-76		-74
	-85			-86		-84
2.516 MHz	-45		0 (Ref)	N/A	N/A	N/A
	-55			-56		-54
	-65			-66		-64
	-75			-76		-74
	-85			-86		-84
270.1 MHz	-45		0 (Ref)	N/A	N/A	N/A
	-55			-56		-54
	-65			-66		-64
	-75			-76		-74
	-85			-86		-84
510.1 MHz	-45		0 (Ref)	N/A	N/A	N/A
	-55			-56		-54
	-65			-66		-64
	-75			-76		-74
	-85			-86		-84
990.1 MHz	-45		0 (Ref)	N/A	N/A	N/A



Table 3-9 Power Level Accuracy Setup 2

Frequency Setting	Power Level Setting (dBm)	Power Meter Reading for -45 dBm	Spectrum Analyzer Marker (dB)	Lower Limit (dBm)	Actual Power Level (dBm)	Upper Limit (dBm)
	-55			-56		-54
	-65			-66		-64
	-75			-76		-74
	-85			-86		-84
1350.1 MHz	-45		0 (Ref)	N/A	N/A	N/A
	-55			-56		-54
	-65			-66		-64
	-75			-76		-74
	-85			-86		-84
1950.1 MHz	-45		0 (Ref)	N/A	N/A	N/A
	-55			-56		-54
	-65			-66		-64
	-75			-76		-74
	-85			-86		-84
2310.1 MHz	-45		0 (Ref)	N/A	N/A	N/A
	-55			-56.2		-53.8
	-65			-66.2		-63.8
	-75			-76.2		-73.8
	-85			-86.2		-83.8
2985.1 MHz	-45		0 (Ref)	N/A	N/A	N/A
	-55			-56.2		-53.8

Table 3-9 Power Level Accuracy Setup 2

Frequency Setting	Power Level Setting (dBm)	Power Meter Reading for -45 dBm	Spectrum Analyzer Marker (dB)	Lower Limit (dBm)	Actual Power Level (dBm)	Upper Limit (dBm)
	-65			-66.2		-63.8
	-75			-76.2		-73.8
	-85			-86.2		-83.8
3225.1 MHz	-45		0 (Ref)	N/A	N/A	N/A
	-55			-56.2		-53.8
	-65			-66.2		-63.8
	-75			-76.2		-73.8
	-85			-86.2		-83.8
4000 MHz	-45		0 (Ref)	N/A	N/A	N/A
	-55			-56.2		-53.8
	-65			-66.2		-63.8
	-75			-76.2		-73.8
	-85			-86.2		-83.8
<b>Option 506</b>						
5000 MHz	-45		0 (Ref)	N/A	N/A	N/A
	-55			-56.5		-53.5
	-65			-66.5		-63.5
	-75			-76.5		-73.5
	-85			-86.5		-83.5
6000 MHz	-45		0 (Ref)	N/A	N/A	N/A
	-55			-56.5		-53.5

Table 3-9 Power Level Accuracy Setup 2

Frequency Setting	Power Level Setting (dBm)	Power Meter Reading for -45 dBm	Spectrum Analyzer Marker (dB)	Lower Limit (dBm)	Actual Power Level (dBm)	Upper Limit (dBm)
	-65			-66.5		-63.5
	-75			-76.5		-73.5
	-85			-86.5		-83.5

Table 3-10 FM Accuracy

Frequency (MHz)	Deviation (kHz)	Limits (kHz)		
		Lower	Measured	Upper
500.001	100 kHz	96.48		103.52
750	100 kHz	96.48		103.52
1000	100 kHz	96.48		103.52

Table 3-11 AM Accuracy

Frequency (MHz)	Depth (%)	Limits (%)		
		Lower	Measured	Upper
200	30	27.5		32.5
200	90	84.5		95.5
300	30	27.5		32.5
300	90	84.5		95.5
501	30	27.5		32.5
501	90	84.5		95.5
750	30	27.5		32.5
750	90	84.5		95.5
1000	30	27.5		32.5
1000	90	84.5		95.5

---

## 4 Regulatory Information

## Statement of Compliance

This product has been designed and tested in accordance with IEC Publication 61010, *Safety Requirements for Electronic Measuring Apparatus*, and has been supplied in a safe condition. The instruction documentation contains information and warnings which must be followed by the user to ensure safe operation and to maintain the product in a safe condition.

---

## Assistance

Product maintenance agreements and other customer assistance agreements are available for Agilent Technologies products. For any assistance, contact Agilent Technologies. (Refer to “[Contacting Agilent Sales and Service Offices](#)” on page 21.)

---

## Certification

Agilent Technologies certifies that this product met its published specifications at the time of shipment from the factory. Agilent Technologies further certifies that its calibration measurements are traceable to the United States National Institute of Standards and Technology, to the extent allowed by the Institute’s calibration facility, and to the calibration facilities of other International Standards Organization members.

---

## Compliance with German Noise Requirements

This is to declare that this instrument is in conformance with the German Regulation on Noise Declaration for Machines (Laermangabe nach der Maschinenlaermrrerordnung -3.GSGV Deutschland).

Table 4-1 German Noise Requirements

Acoustic Noise Emission/Geraeuschemission	
LpA < 70 dB	LpA < 70 dB
Operator position	am Arbeitsplatz
Normal position	normaler Betrieb
per ISO 7779	nach DIN 45635 t.19

## Declaration of Conformity

A copy of the Manufacturer's EU Declaration of Conformity for this instrument can be obtained by contacting your local Agilent Technologies sale representative. (Refer to [“Contacting Agilent Sales and Service Offices”](#) on page 21.)

Regulatory Information  
**Declaration of Conformity**



**A**

ac power cord  
  connection 10  
ac symbol 3  
accessories 17  
address, GPIB 14  
adjusting display during remote operation 13  
altitude requirements 9  
AM accuracy check 35  
assistance 56  
Australian Communications Authority (C-tick)  
  mark 3

**B**

brightness adjustment 12

**C**

Canadian Standards Association (CSA) mark 3  
checking the shipment 8  
cleaning suggestions 19  
configuring  
  global settings 12  
  GPIB interface 14  
  remote control settings 14  
  RS-232 interface 16  
configuring the signal generator 27, 29, 30, 33, 35  
connecting test equipment 27, 29, 30, 33, 35  
contrast adjustment 12

**D**

declaration of conformity 57  
DHCP configuration 15  
display adjustment  
  contrast and brightness 12  
  inverse video 12  
  light 13  
  screen saver 12  
  update during remote operation 13  
documentation v  
documentation, list of available 17

**E**

equipment required  
  verification procedures 24

error messages, checking for 26  
ESG documentation 17  
European Community (CE) trademark 3

**F**

FM accuracy check 33  
frequency range and accuracy check 27

**G**

German noise requirements 56  
global settings 12  
GPIB configuration  
  address 14  
  interface 14  
guides v

**H**

hostname configuration 14

**I**

I/Q modulation check 37  
IEC Publication 61010 56  
installation guide v  
instruction manual symbol 3  
inverse video adjustment 12  
IP address, setting 14  
ISM1-A symbol 3

**K**

kits  
  front handles 17  
  rack mount, with handles 17

**L**

LAN configuration 14

**M**

maintenance agreements 56  
Manual Configuration 14  
manual configuration 14  
measuring  
  FM deviations 34  
  frequency accuracy 28  
  power level accuracy 30, 31

---

# Index

## O

ordering accessories [17](#)  
output power level check [29](#)

## P

parallel interface. *See* GPIB configuration [14](#)  
power on symbol [3](#)  
powering on [25](#)  
programming guide [v](#)

## R

references [v](#)  
remote configuring [14](#)  
required test equipment  
  verification procedures [24](#)  
requirements  
  altitude [9](#)  
  electrical [9](#)  
  environmental [9](#)  
  German Noise [56](#)  
  humidity [9](#)  
  temperature [9](#)  
  ventilation [9](#)  
returning a signal generator [20](#)  
RS-232 configuration  
  baud rate [16](#)  
  echo [16](#)  
  reset [16](#)  
  timeout [16](#)

## S

SCPI reference [v](#)  
screen saver adjustment [12](#)  
service  
  guide [v](#)  
service, Agilent sales and service offices [21](#)  
signal generator  
  configuring [27](#), [29](#), [30](#), [33](#), [35](#)  
  powering up [25](#)  
signal generator checks  
  AM Accuracy [35](#)  
  FM Accuracy [33](#)  
  frequency range and accuracy [27](#)  
  I/Q Modulation [37](#)

  power level accuracy [29](#)  
standby symbol [3](#)  
symbols  
  ac [3](#)  
  CE mark [3](#)  
  CSA mark [3](#)  
  C-tick mark [3](#)  
  instruction manual [3](#)  
  ISM1-A [3](#)  
  power on [3](#)  
  standby [3](#)

## T

tables  
  verification procedures [44](#)  
temperature requirements [9](#)  
test equipment  
  configuring  
    frequency counter [27](#)  
    measuring receiver [33](#), [35](#)  
    power meter [30](#)  
    spectrum analyzer [31](#)  
  connecting [27](#), [29](#), [30](#), [33](#), [35](#)  
  verification procedures [24](#)  
test tables  
  AM accuracy [54](#)  
  FM accuracy [53](#)  
  frequency accuracy [44](#)  
  power level accuracy (setup 1) [45](#)  
  power level accuracy (setup 2) [50](#)

## U

user  
  documentation [v](#)

## V

ventilation  
  holes [9](#)  
  requirements [9](#)  
verification  
  procedures [24](#)  
  tables [44](#)